

Product data

Product code	VA01-0156	STK-code	5200319	EAN-code	6410052003197
Product name	PKK cable lug 10-6-90				

Technical data

Cable material	Cu	
Nominal cross section for cable	10	mm ²
Weight	8	g

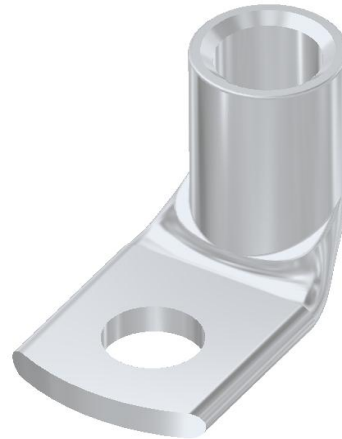

Material/ Coating	Tin plated copper
Mounting/ Connection	Crimping

Description

Ouneva PKK-series copper cable lugs are designed for connecting copper cables, coils and busbars. The lugs are manufactured of 99,9 % pure copper and electrolytically coated with tin. Installation of the cable lugs can be performed with the most basic crimping tools. PKK-series cable lugs are available with both 90° and 45° angle and compatible with all kinds of stranded wires.

Drawing

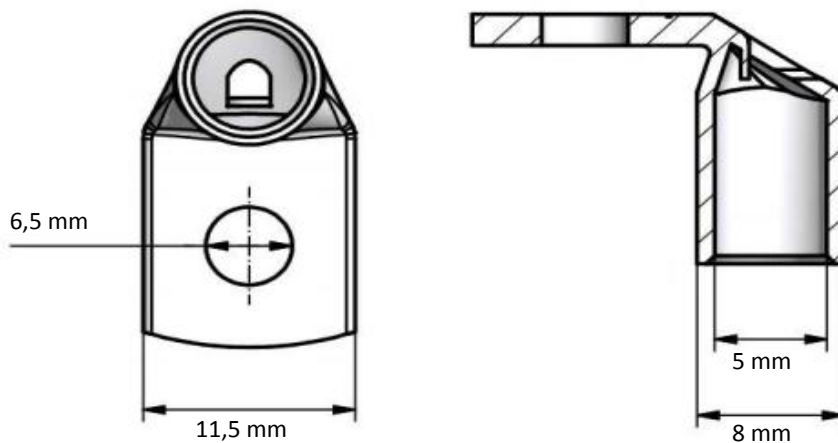

Package

Package	Box	Pcs / Package	50	Weight [kg]	0,42
Length [mm]	60	Width [mm]	47	Height [mm]	97