

0049284 0049285
0049286 0049287

0049288 0049289
0049290 0049291

f = 5.8 GHz ± 75 MHz
P_{max} = 0.2 mW

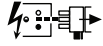
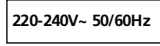

1

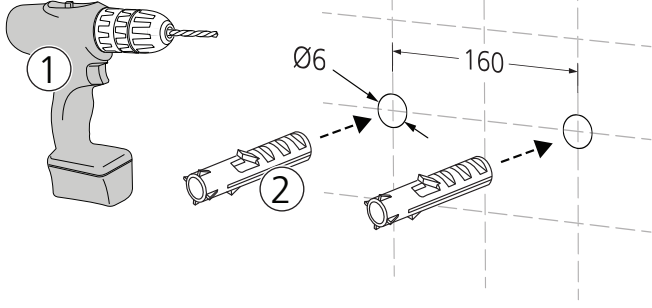

2

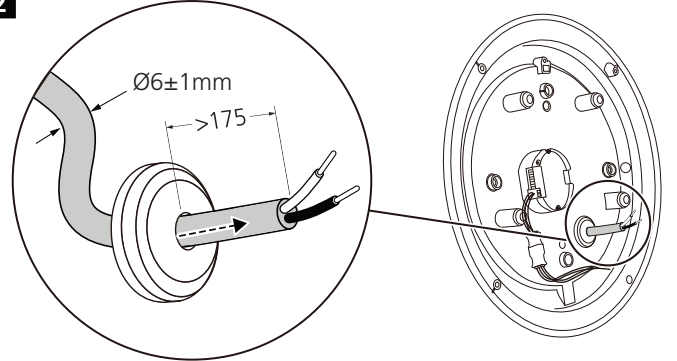

3 ⚡ 230-240V

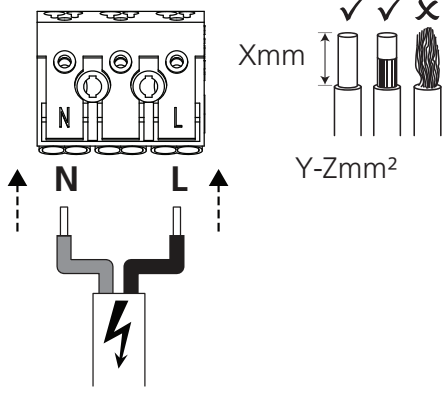

4

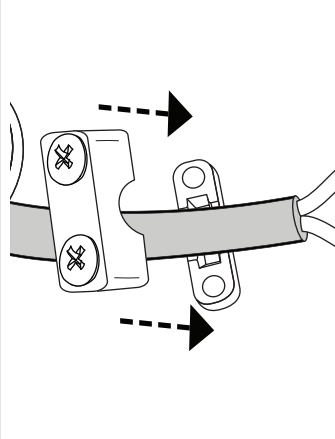

5

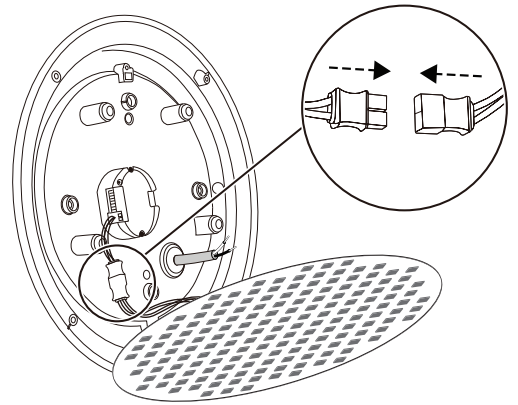

6

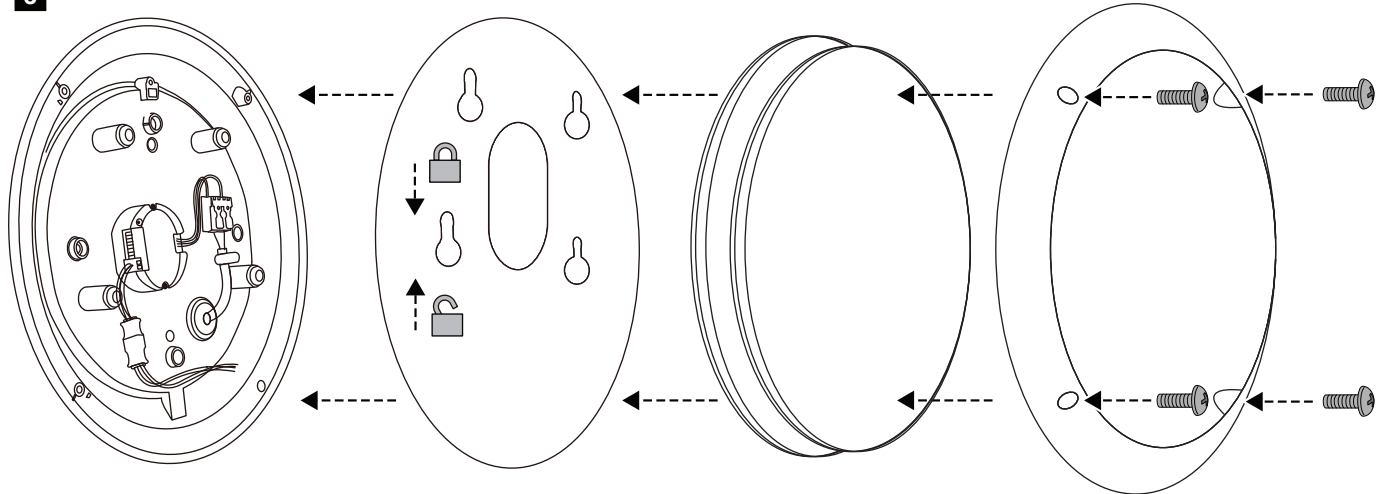

7a Sensitivity
0049288, 0049289, 0049290, 0049291

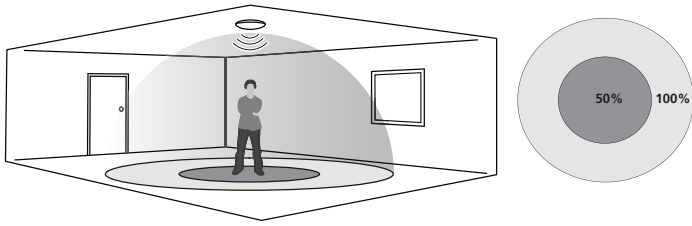

7b Sensitivity

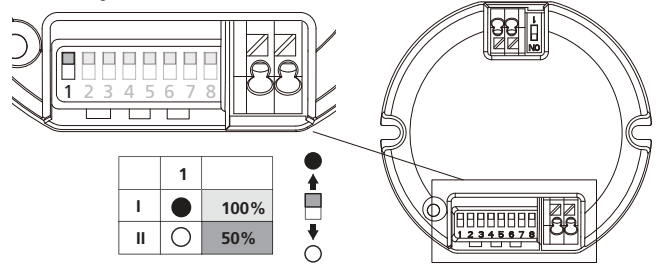

8a Hold time
0049288, 0049289, 0049290, 0049291

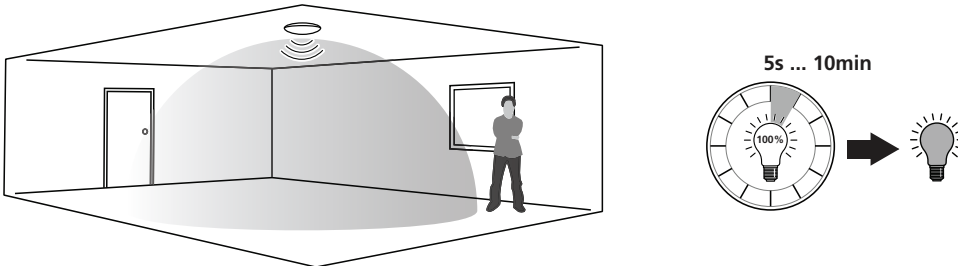

8b Hold time

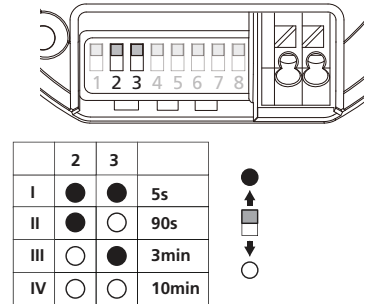

9a Stand-by time
0049288, 0049289, 0049290, 0049291

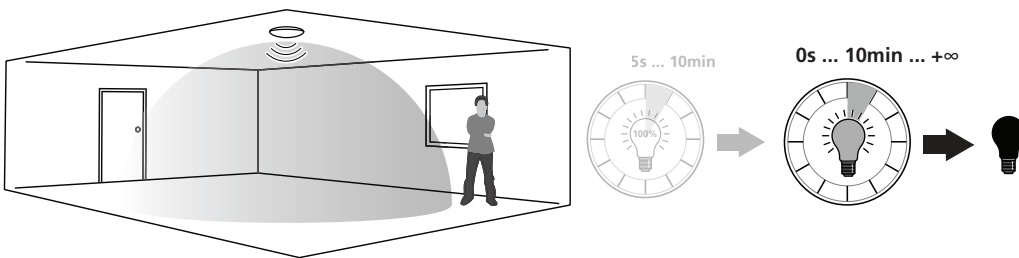

9b Stand-by time

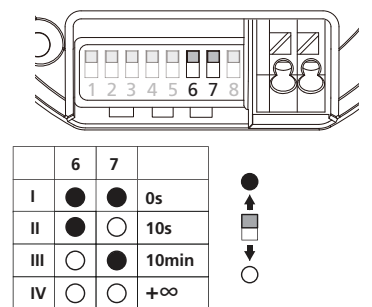

10a Stand-by dimming level
0049288, 0049289, 0049290, 0049291

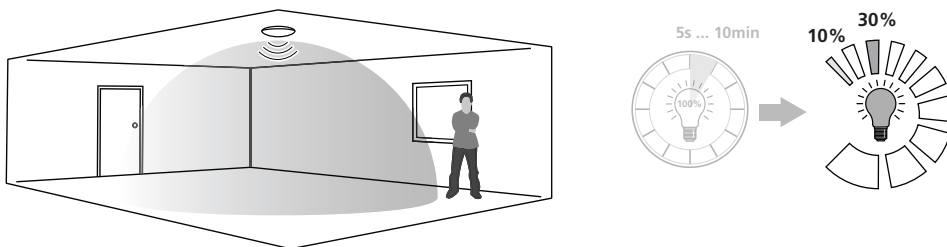

10b Stand-by dimming level

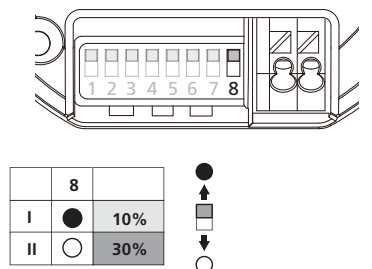

11a Daylight sensor
0049288, 0049289, 0049290, 0049291

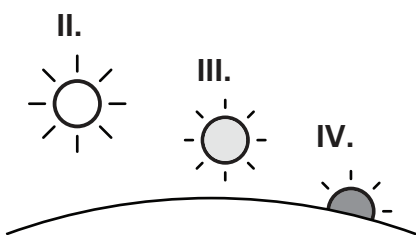

11b Daylight sensor

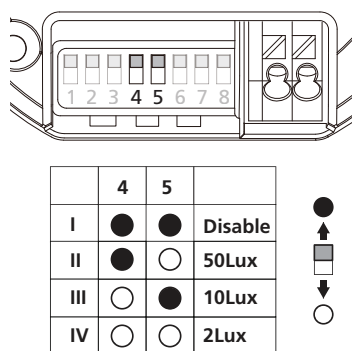

12 Output current
0049288, 0049289, 0049290, 0049291

