

Continuum (C)
 Continuum Trim (CT)
 Mini Continuum (MC)
 Mini Continuum Trim (MCT)
 Lytebeam (LB)
 Lytespan 1 (L1)
 Lytespan 1 Recessed (L1R)
 Lytespan 3 (L3)
 Lytespan 3 Recessed (L3R)

UK ✓	C CT MC MCT L1 L1R T1 L3 L3R LB	UK ✗	C CT MC MCT L3 L3R LB
	1 x 16A Max		1 x 16A Max
	1 x P/L		3 x P/L
	1 x N		1 x N
	1 x		1 x

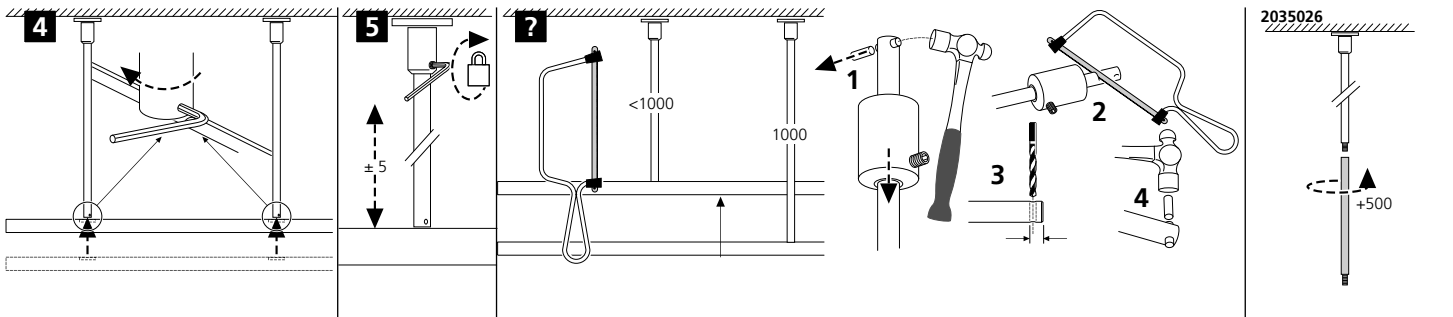

2035014 2035015 2035017 2035018

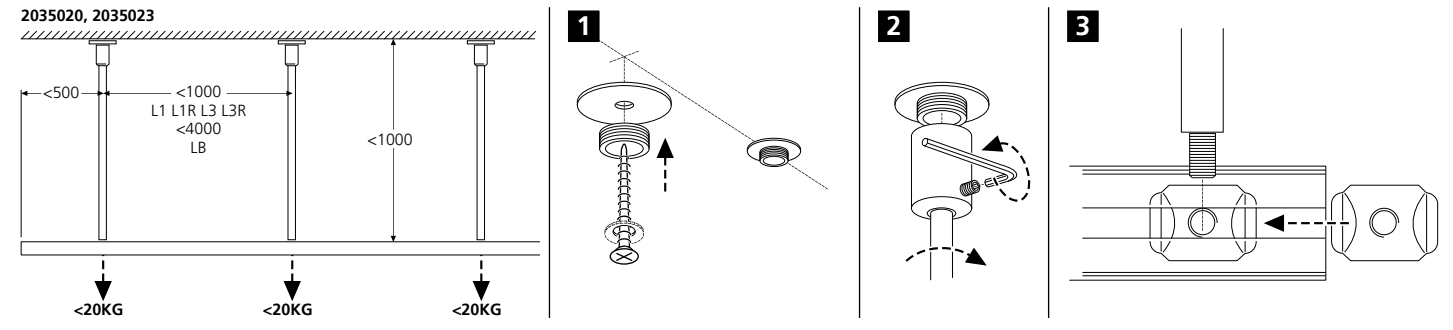
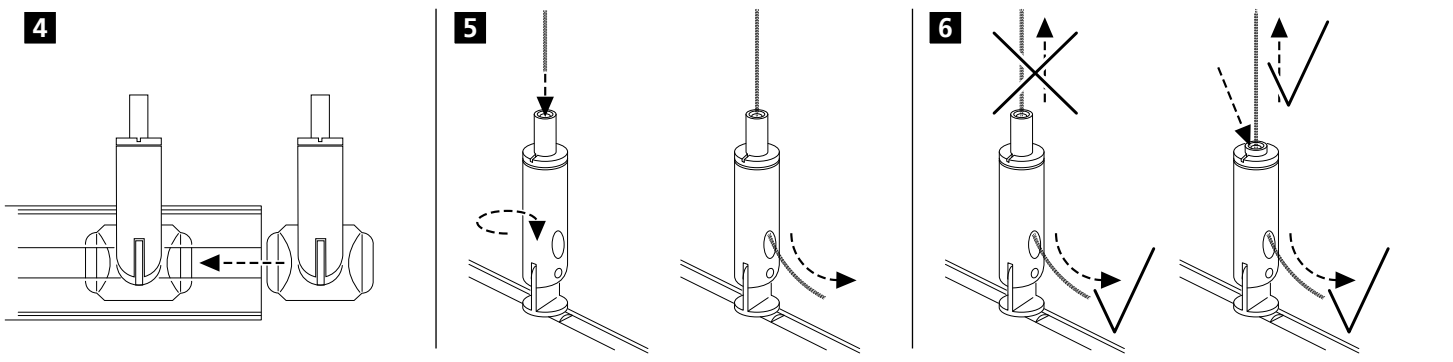
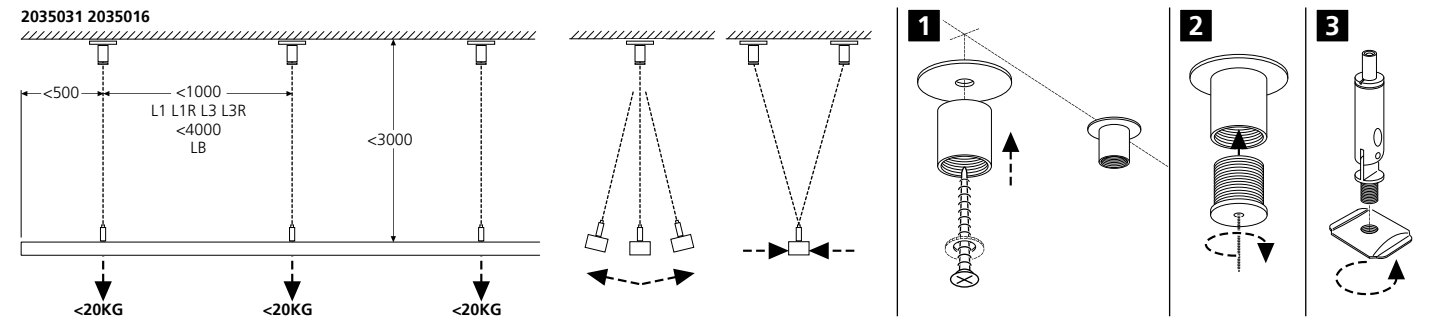
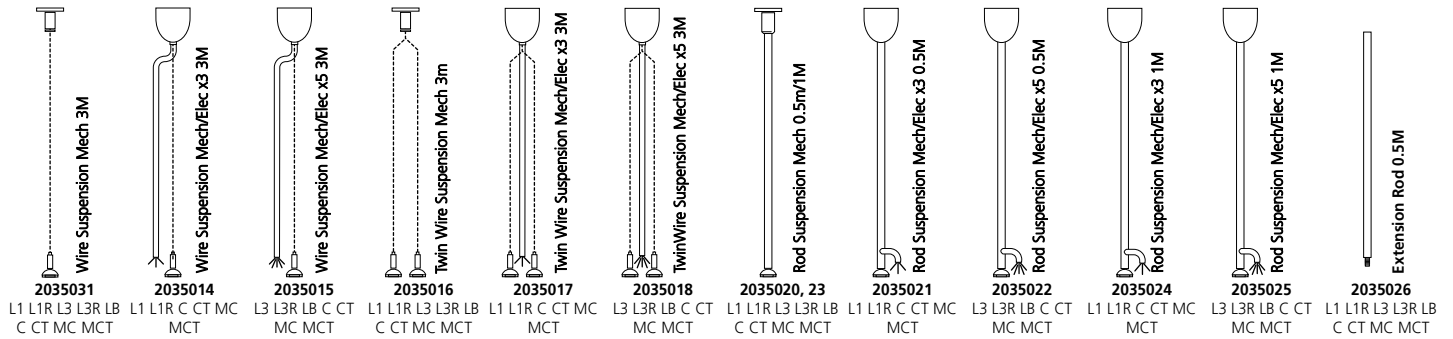
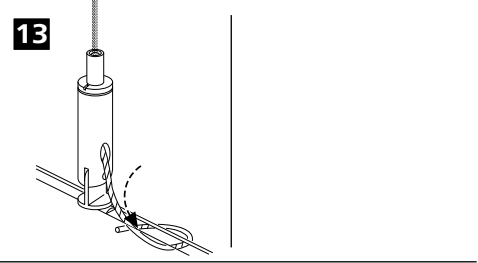
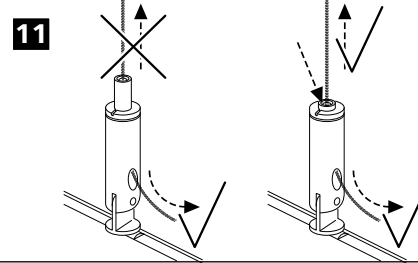
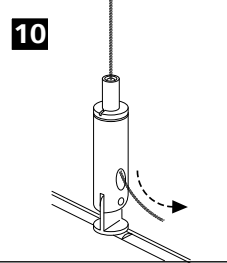
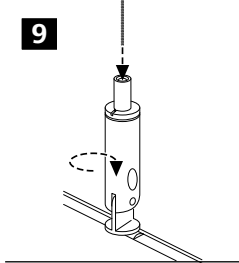
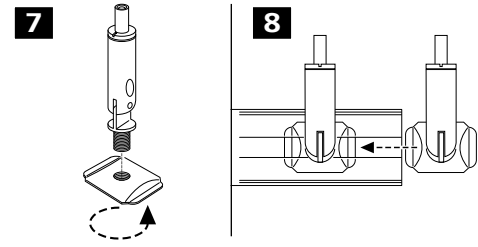
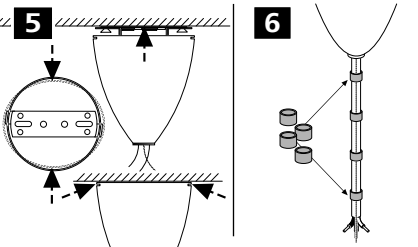
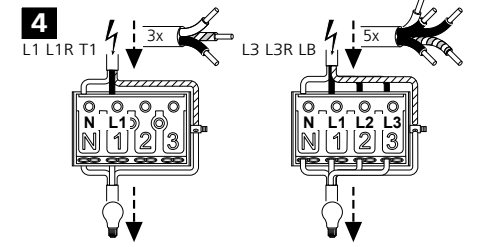
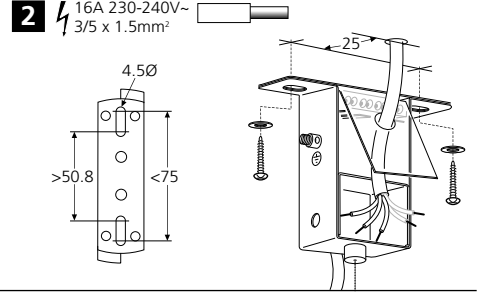
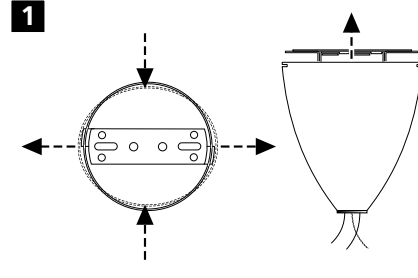
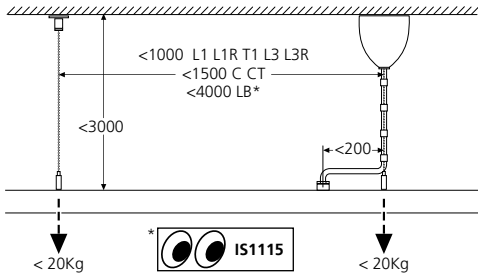

2035021 2035022 2035024 2035025

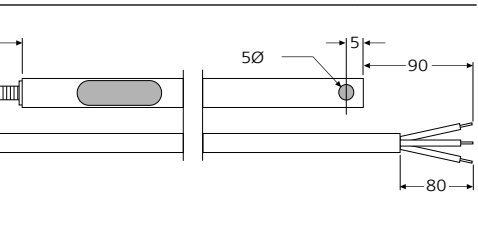
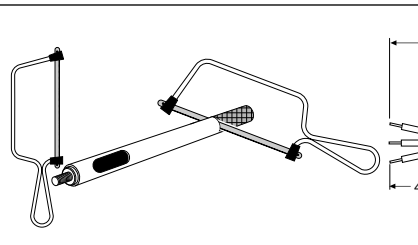
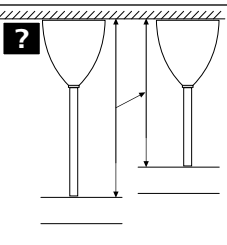
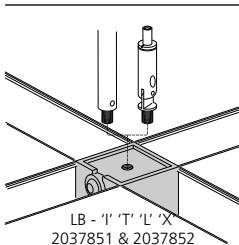
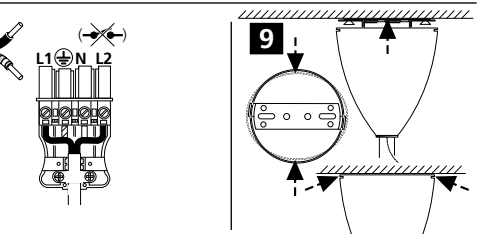
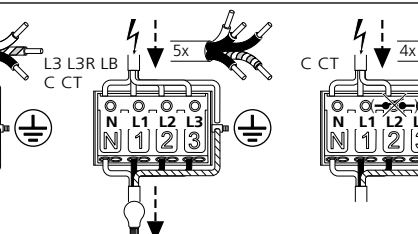
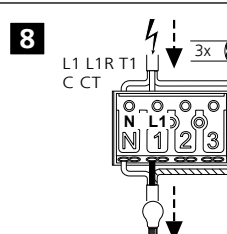
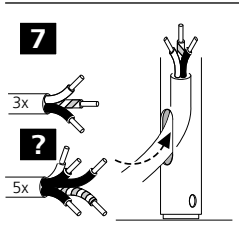
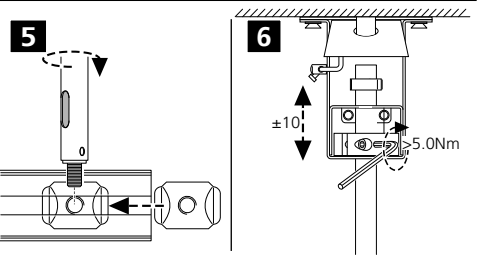
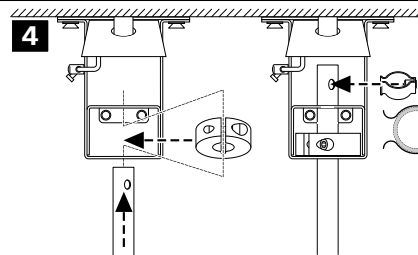
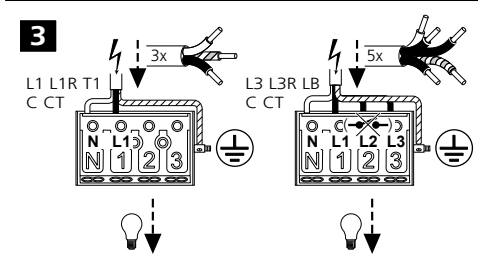
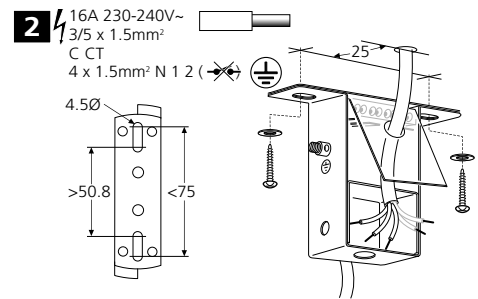
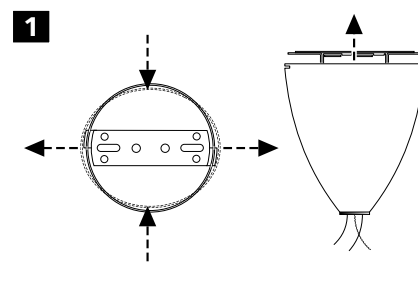
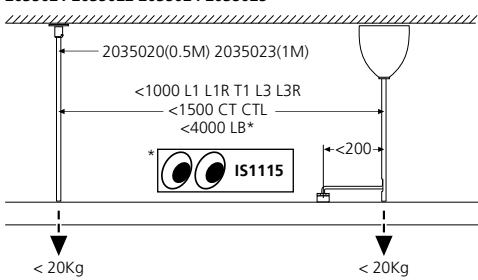

Concord

Havells Sylvania Europe LTD
Avis Way, Newhaven East Sussex BN9 0ED UK
www.havells-sylvania.com



EM539002 FM01687 © Concord Lighting Limited 03.14