

# VALAISINKISKO MEK

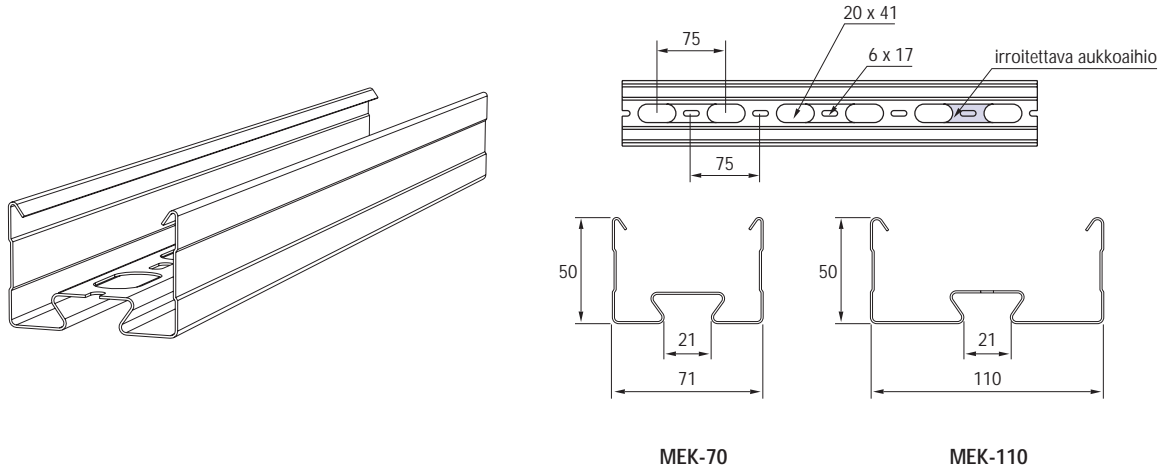

MEK-70

MEK-110

TUOTE	SSTL-NUMERO	VARASTO-PAKAUS	PAINO KG /100 KPL	PITUUS	AINEVAHVUUS MM
-------	-------------	----------------	-------------------	--------	----------------

**Kuumasinkitty ohutlevy**

MEK 70 K	14 493 11	180 m	130	6 m	0,75
MEK 70	14 493 12	180 m	170	6 m	1,00
MEK 110	14 493 13	108 m	200	6 m	1,00

**Kuumasinkitty maalipintainen ohutlevy, väri valkoinen RAL 9010**

MEK 70 M	14 493 15	180 m	130	6 m	0,75
MEK 110 M	14 493 17	108 m	200	6 m	1,00

**KUORMITUSKÄYRÄT**

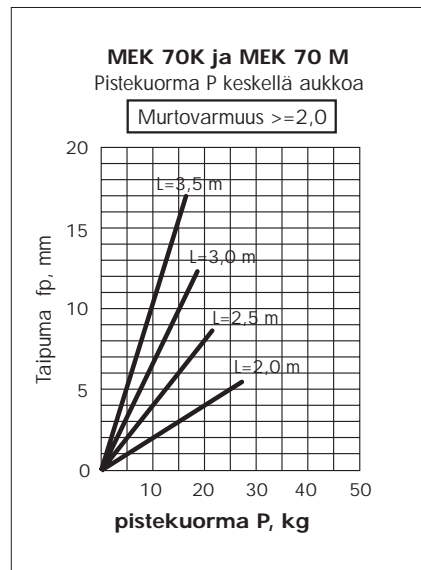
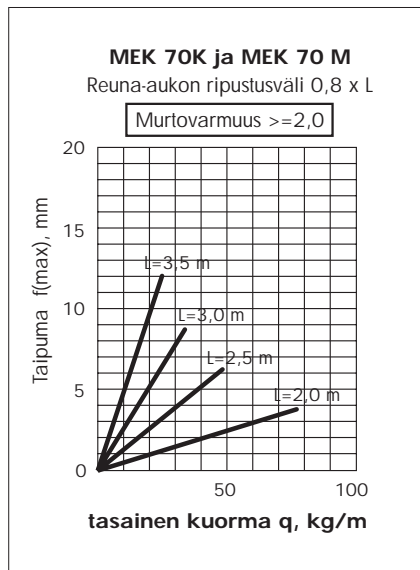
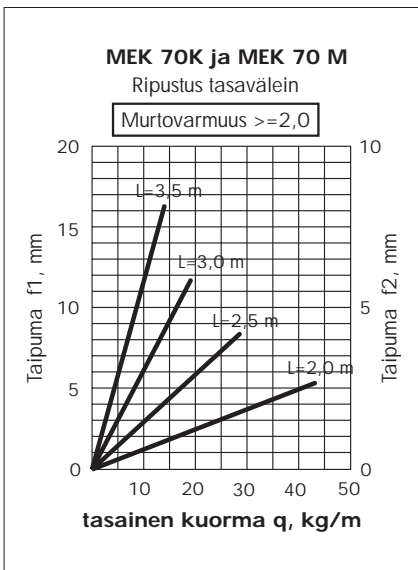
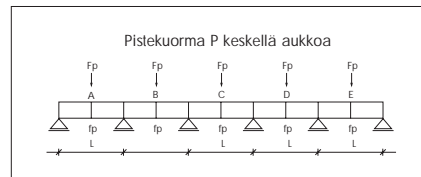
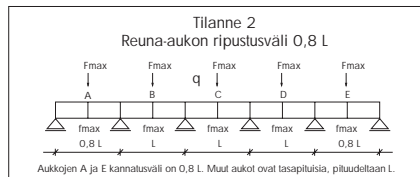
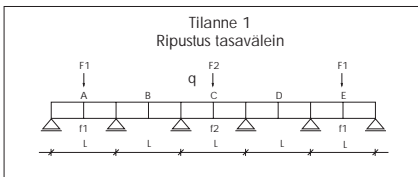

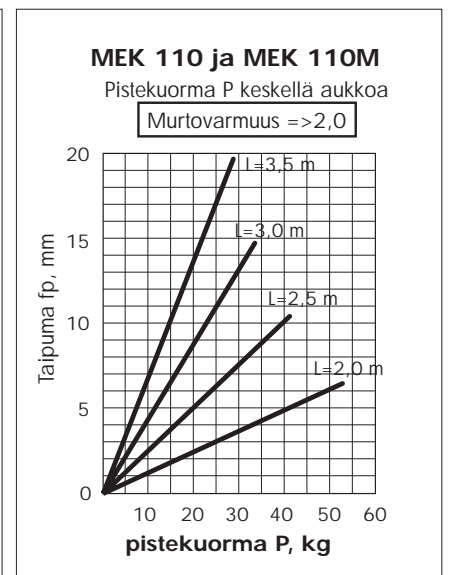
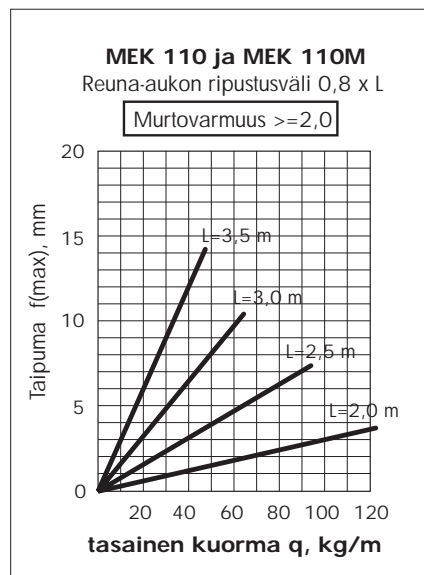
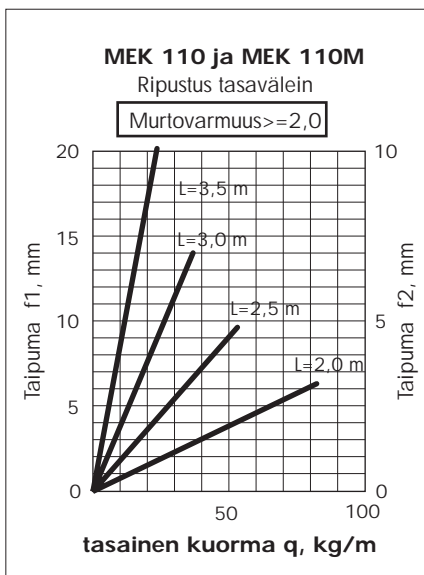
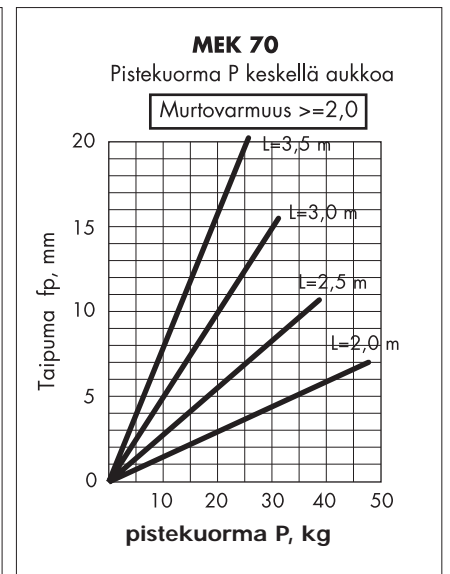
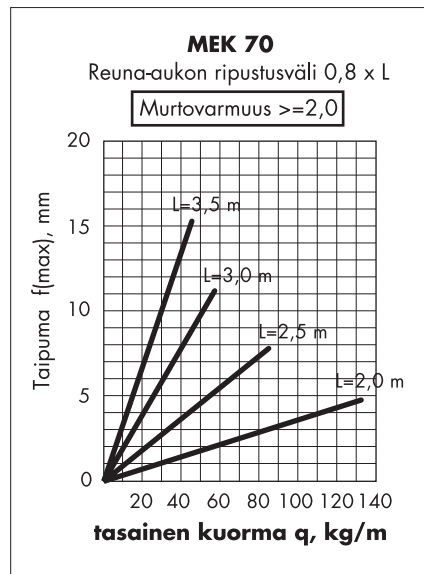
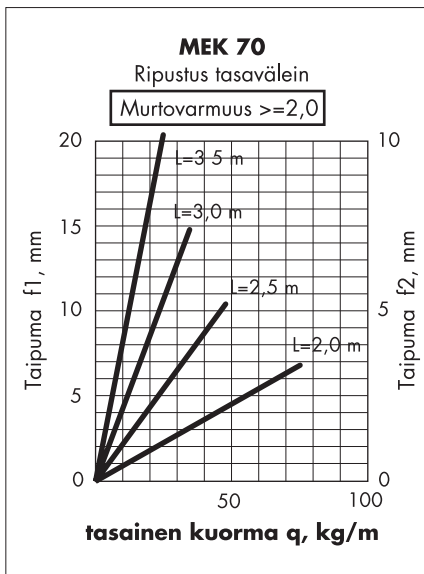

Valaisinkiskojen kuormituskäyrien lukuohje sivulla 11.